



**N-channel 100V, 1A, SOT-23 Power MOSFET 功率場效應管**

■ **Features 特點**

Low on-resistance and maximum DC current capability 低導通電阻和最大直流電流能力

Super high density cell design 超高元胞密度設計

$R_{DS(ON)}$ TYP520mΩ@VGS=10V

$R_{DS(ON)}$ TYP550mΩ@VGS=4.5V

■ **Applications 應用**

Boost Converter 升壓轉換

Synchronous Rectifier 同步整流

LED Backlighting LED 背光驅動

■ **Internal Schematic Diagram 內部結構**

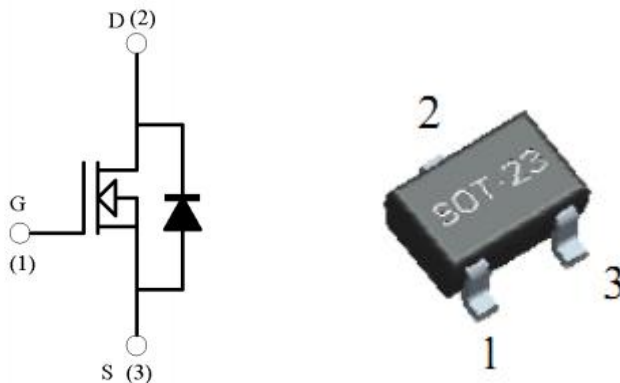

■ **Absolute Maximum Ratings 最大額定值**

Characteristic 特性參數	Symbol 符號	Rat 額定值	Unit 單位
Drain-Source Voltage 漏極-源極電壓	$BV_{DSS}$	100	V
Gate- Source Voltage 柵極-源極電壓	$V_{GS}$	+20	V
Drain Current (continuous)漏極電流-連續	$I_D$ (at TC = 25°C)	1	A
Drain Current (pulsed)漏極電流-脈沖	$I_{DM}$	4	A
Total Device Dissipation 總耗散功率	$P_{TOT}$ (at TC = 25°C)	1.4	W
Thermal Resistance Junction-Ambient 熱阻	$R_{\theta JA}$	100	°C/W
Junction/Storage Temperature 結溫/儲存溫度	$T_J, T_{stg}$	-55~150	°C



■ Electrical Characteristics 電特性

( $T_A=25^{\circ}\text{C}$  unless otherwise noted 如無特殊說明，溫度為  $25^{\circ}\text{C}$ )

Characteristic 特性參數	Symbol 符號	Min 最小值	Typ 典型值	Max 最大值	Unit 單位
Drain-Source Breakdown Voltage 漏極-源極擊穿電壓( $I_D=250\mu\text{A}, V_{GS}=0\text{V}$ )	$BV_{DSS}$	100	—	—	V
Gate Threshold Voltage 柵極開啓電壓( $I_D=250\mu\text{A}, V_{GS}=V_{DS}$ )	$V_{GS(th)}$	1	1.5	3	V
Zero Gate Voltage Drain Current 零柵壓漏極電流( $V_{GS}=0\text{V}, V_{DS}=80\text{V}$ )	$I_{DSS}$	—	—	1	$\mu\text{A}$
Gate Body Leakage 柵極漏電流( $V_{GS}=\pm 20\text{V}, V_{DS}=0\text{V}$ )	$I_{GSS}$	—	—	$\pm 100$	nA
Static Drain-Source On-State Resistance 静态漏源導通電阻( $I_D=1\text{A}, V_{GS}=10\text{V}$ ) ( $I_D=0.8\text{A}, V_{GS}=4.5\text{V}$ )	$R_{DS(on)}$	—	520 550	630 720	$\text{m}\Omega$
Source Drain Current 源極-漏極電流	$I_{SD}$	—	—	1	A
Diode Forward Voltage Drop 內附二極管正向壓降( $I_{SD}=1\text{A}, V_{GS}=0\text{V}$ )	$V_{SD}$	—	—	1.2	V
Input Capacitance 輸入電容 ( $V_{GS}=0\text{V}, V_{DS}=50\text{V}, f=1\text{MHz}$ )	$C_{ISS}$	—	100	—	pF
Common Source Output Capacitance 共源輸出電容( $V_{GS}=0\text{V}, V_{DS}=50\text{V}, f=1\text{MHz}$ )	$C_{OSS}$	—	13	—	pF
Reverse Transfer Capacitance 回饋電容 ( $V_{GS}=0\text{V}, V_{DS}=50\text{V}, f=1\text{MHz}$ )	$C_{RSS}$	—	10	—	pF
Total Gate Charge 柵極電荷密度 ( $V_{DS}=50\text{V}, I_D=1\text{A}, V_{GS}=10\text{V}$ )	$Q_g$	—	1	—	nC
Gate Source Charge 柵源電荷密度 ( $V_{DS}=50\text{V}, I_D=1\text{A}, V_{GS}=10\text{V}$ )	$Q_{gs}$	—	0.4	—	nC
Gate Drain Charge 柵漏電荷密度 ( $V_{DS}=50\text{V}, I_D=1\text{A}, V_{GS}=10\text{V}$ )	$Q_{gd}$	—	0.8	—	nC
Turn-On Delay Time 開啓延遲時間 ( $V_{DS}=50\text{V}, I_D=1\text{A}, R_{GEN}=3\Omega, V_{GS}=10\text{V}$ )	$t_{d(on)}$	—	5	—	ns
Turn-On Rise Time 開啓上升時間 ( $V_{DS}=50\text{V}, I_D=1\text{A}, R_{GEN}=3\Omega, V_{GS}=10\text{V}$ )	$t_r$	—	4	—	ns
Turn-Off Delay Time 關斷延遲時間 ( $V_{DS}=50\text{V}, I_D=1\text{A}, R_{GEN}=3\Omega, V_{GS}=10\text{V}$ )	$t_{d(off)}$	—	12	—	ns
Turn-On Fall Time 開啓下降時間 ( $V_{DS}=50\text{V}, I_D=1\text{A}, R_{GEN}=3\Omega, V_{GS}=10\text{V}$ )	$t_f$	—	5	—	ns

■ TYPICAL CHARACTERISTIC CURVE 典型特性曲线

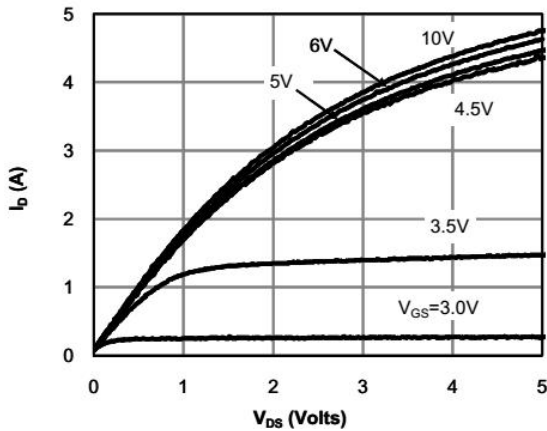

Figure 1. Output Characteristics

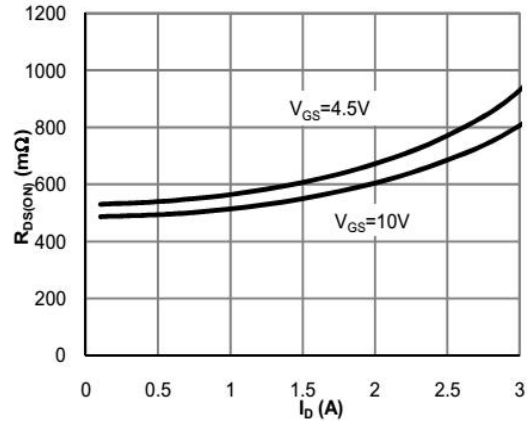

Figure 2. On-Resistance Characteristics

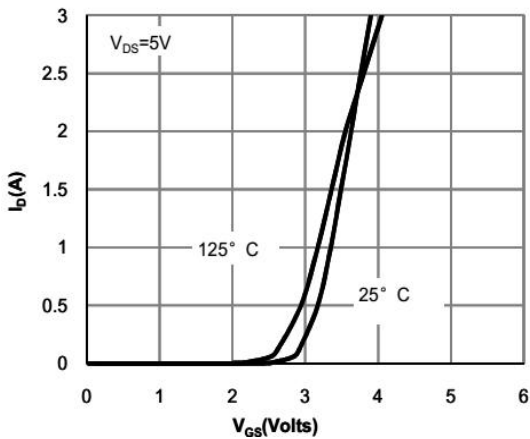

Figure 3. Transfer Characteristics

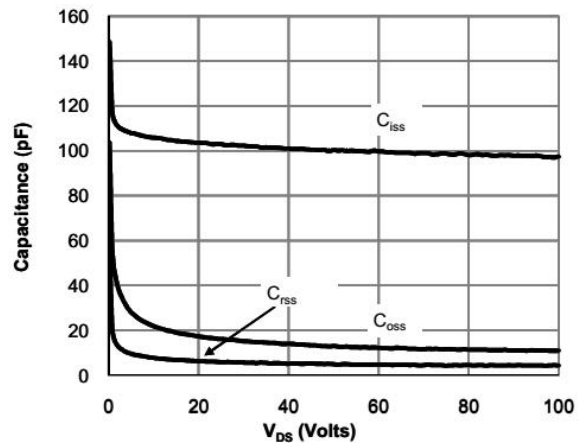

Figure 4. Capacitance Characteristics

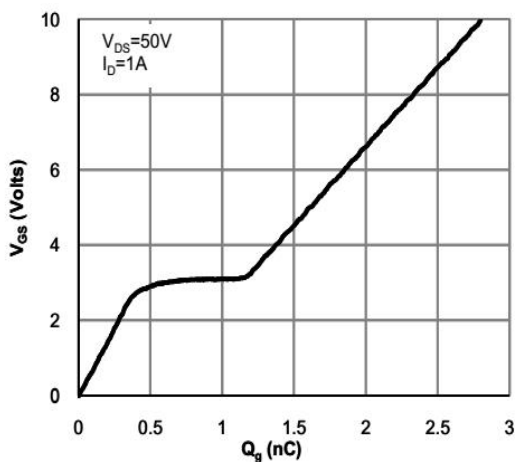

Figure 5. Gate charge

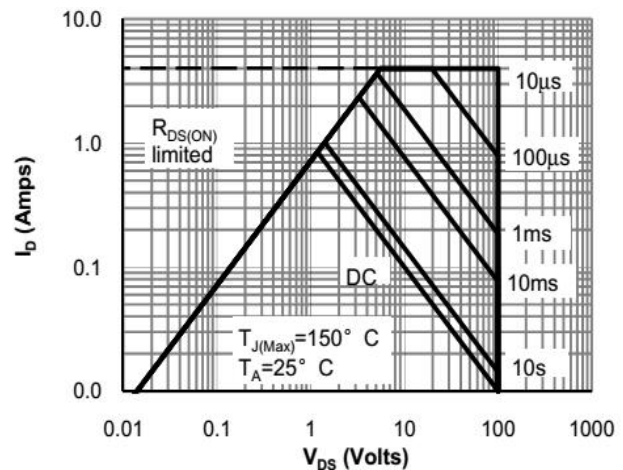

Figure 6. Maximum Safe Operating Area